

MODEM History Overview

By Bob Pollard

MODEM History Overview:

The original MODEM (Modulator–Demodulator) was designed to provide a means for using telephone facilities for the transmission / reception of digital data. In the present day world MODEM(s) are used on all type of facilities.

One of the first commercial full duplex MODEM was introduced in 1962 by AT&T, the Bell 103, and was called a 'Data Set'. This MODEM provided full duplex operation, used Frequency Shift Keying (FSK) and operated at a speed of 300 Baud.

The 300 baud full-duplex MODEM operated at the same bit per second rate in both directions. This full-duplex operation is possible because of different carrier frequencies (tones) used by each end. For example: one end, the 'originate' MODEM, may transmit a 1,070 Hertz tone for a '0' and a 1,270 Hertz tone for a '1' ; The 'answer' MODEM would transmit a 2,025 Hertz tone for a '0' and a 2,225 tone for a '1'. Since different tones are used by the 'originate' and 'answer' MODEM, simultaneous (full-duplex) operation is possible. The Answer and Originate terms identify the different frequency(s) used by the MODEM on each end of the circuit.

Today a much faster bit per second transmission rate is possible on a voice grade facility, 3000-3300 Hertz bandwidth, using sophisticated modulation techniques. At this time the 56 Kbps (thousand bits per second) MODEM is about the limit on a pure voice grade channel (line) and it actually connects at a lower bit per second rate because of imperfect lines / equipment. This connection limit (capability) on a voice grade line usually restricts the 56Kbps connection rate to a level between 14Kbps to 50Kbps.

As the MODEM developed different varieties and capabilities became available, such as modulation schemes and protocol control features.

A typical example is shown in the following illustration, Figure A, utilizing Frequency Modulation (FM):

Figure A illustrates both the modulation and demodulation features and the use of clocking pulses that would be used in a synchronous operation. In this example, involving early MODEM(s), clock pulses are sent by each MODEM to the connected device, computer / terminal, to inform them of the clocking scheme / rate. The clock pulses are generated by the oscillators in the MODEM. The MODEM on each end is tuned to the proper clock frequency at the time of installation.

A modern MODEM will go through a handshaking procedure during the connection process to establish the usable bit rate and the clock rate will be set accordingly. This should not be confused with synchronous operation where the synchronous bits are interspersed within the transmitted bit stream, which is a different method of synchronization.

A modulated signal (A.C.) is what occurs when two different frequencies are merged or beat against each other. For instance the MODEM might use a carrier frequency of 1 kilocycle and a 2 kilocycle frequency to modulate the carrier frequency based on the one D.C. bit stream. In the example, Figure A, the carrier signal would represent the 0 bit and the modulated signal (1 k c and 2 k c merged) would represent the 1 bits.

MODEM History Overview

By Bob Pollard

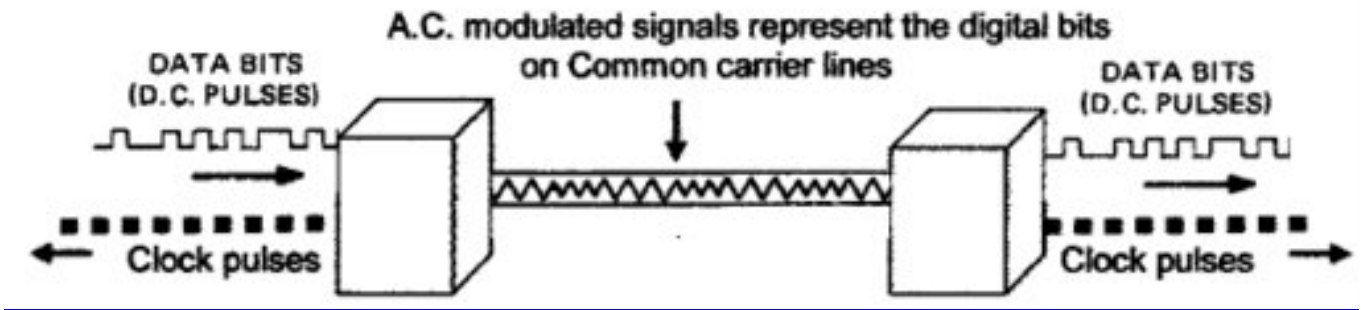

Figure A

Figure 1A & B provides an example of early usage Di-bit (2 bits) and Tri-bit (3 bits) amplitude carrier modulation. These modulation features combines more than one bit together and the combined bits create a single modulated signal. This modulation scheme was initiated and began life with an early MODEM. There are a multitude of modulation features / schemes used in various MODEM(s) and they are discussed in other pages.

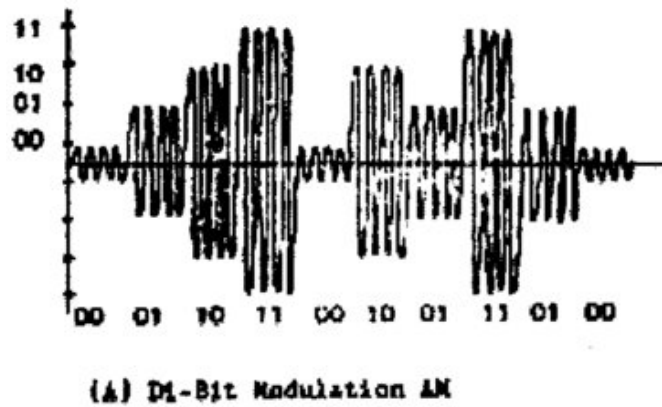

Figure 1A

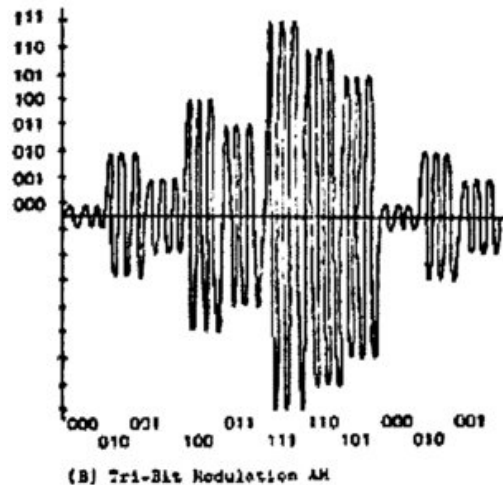

Figure 1B

MODEM History Overview

By Bob Pollard

The MODEM connection to a distant MODEM (terminal) could be via a dial up connection over a telephone line. In the beginning the dial up connection had to be accomplished independent of the MODEM because the early MODEM(s) did not provide this feature, which is built into the present day MODEM. As illustrated in Figure 2 the dial connection involves routing through many switching matrices in order to reach the final destination. A leased or private line would be a direct connection through each point along the line eliminating the switching requirement, review Figure 3. This is important because interference (noise / distortion / bias) is reduced when switched (changeable) lines and switch connections are not required.

This connection process also takes place in today's world, except the equipment and lines are modernized.

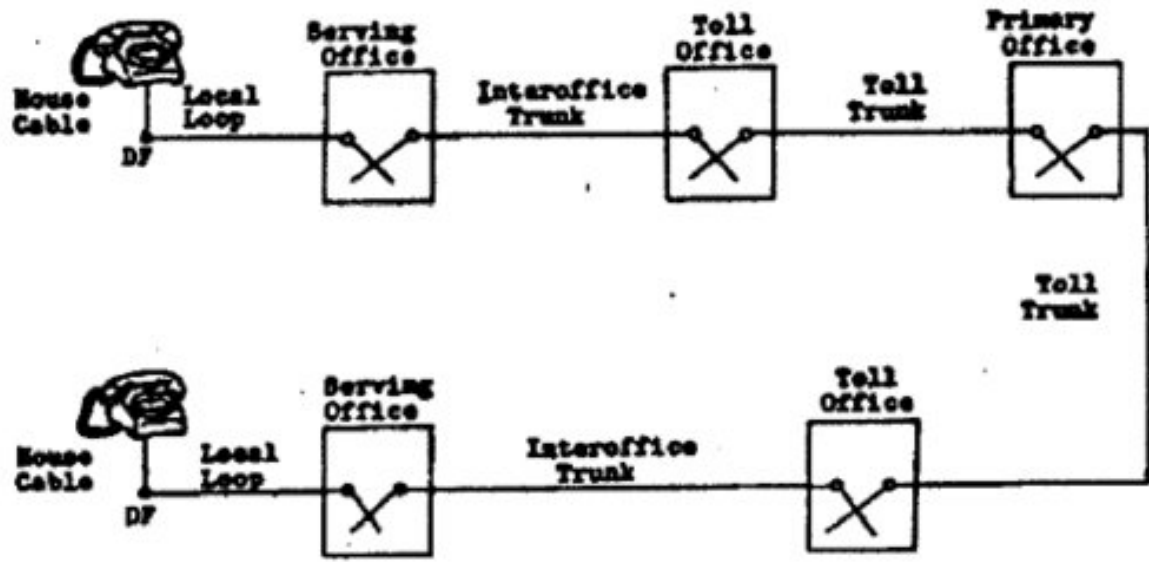

Telephone Channel Composition
DF = Distribution Frame within the building
Figure 2

In addition to the early manual dial up connection process an acoustic coupler could also be used. This was a flat cradle, 'acoustic coupling' that was configured to hold the telephone handset. The openings for the handset talking and listening end were light pressure fitted (pushed down) into the tight fitting rubber or foam cups, review Figure 4. This insulated fit was necessary to eliminate outside interference. Once the handset was in place and a dial up connection via the telephone had been accomplished the MODEM could begin transmission. This operation could use a MODEM utilizing audio tones similar to voice signals or a data transmission MODEM modulating a generated carrier frequency; a compatible MODEM on each end was necessary. The MODEM speaker part is placed in contact with the telephone microphone (on the handset) so that the tones from the MODEM are transmitted into the telephone. The MODEM microphone part receives the tones from the telephone handset speaker. This operation was primarily used for low speed 300 Baud operation, although higher speeds could be used.

Direct Distant Dialing (DDD) is an AT & T term used by private parties and maintenance personnel when they refer to dial up connections, whether it is for a telephone call or to send data via a telephone facility.

MODEM History Overview

By Bob Pollard

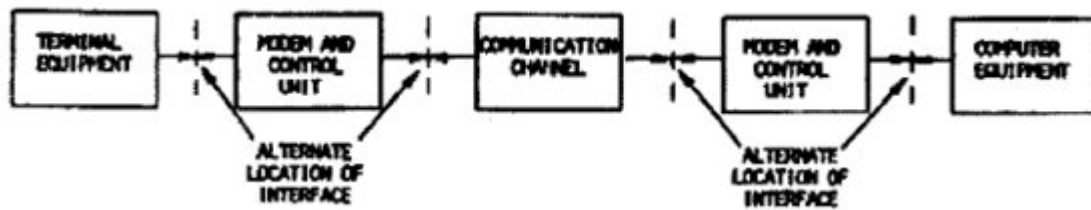

Private Line Service
Figure 3

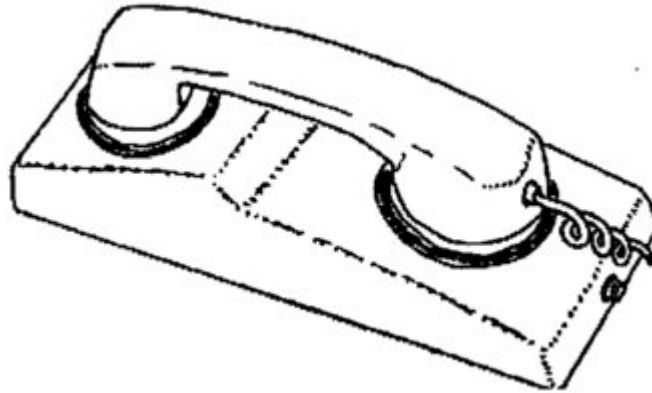

Figure 4

A typical 1960's & 70's handshaking (control) interface between a MODEM and a terminal is illustrated in Figure 5. The DTE (Data Terminal Equipment) side is the terminal signaling and the DCE (Data Communication Equipment) side is the MODEM control signals. The numbers represent the sequence of events as they occur.

A typical dial up handshaking (control) interface (1960's & 70's) between a MODEM, Automatic Calling Unit and a terminal is illustrated in Figure 6. The Data Terminal Equipment (DTE) side is the terminal control signals to and from the Automatic Calling Unit and the MODEM. The numbers represent the sequence of events as they occur. An Automatic Calling Unit was used in conjunction with the MODEM because dialing capabilities was not available in the MODEM during this time period. Today the calling and MODEM unit would be combined into a single MODEM. The MODEM may be a part of the Data Terminal Equipment (DTE) or the Data Communication Equipment (DCE), which are terms used for a conglomeration of equipment.

Major advancements in MODEM design has occurred since the beginning (1962) and now it's a trouble free (almost) and fast world. But, in the 1960's 1200 to 9600 bit per second (bps) using a synchronous mode was a major accomplishment. At the higher bps rates it was very difficult to keep the Carrier / MODEM synchronized because of the sensitive timing (clock) electronics and, therefore, they were a high maintenance item. The MODEM / Carrier on each end were tuned to the proper clock frequency at the time of installation and the MODEM / Carrier did not have automatic clock timing or bps rate adjustments. Also the receiving MODEM / Carrier could not communicate with the sending MODEM / Carrier in order to correct the bps rate for error free reception. If the data bit stream shifted (bias problem) or a distortion problem occurred an error condition would be indicated. This would require manual intervention by maintenance personnel in order to readjust the internal clock (timing) electronics or correct the distortion problem.

MODEM History Overview

By Bob Pollard

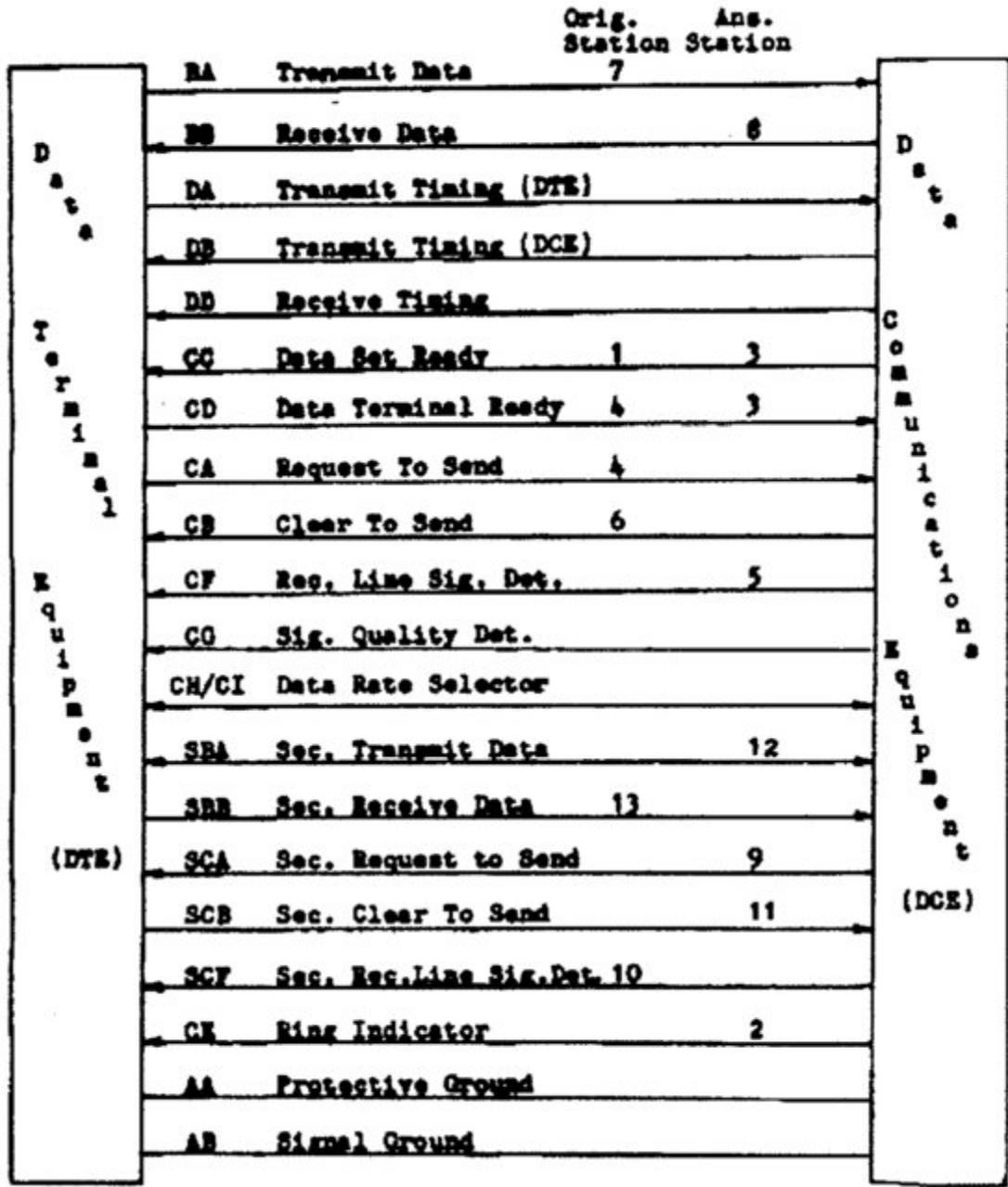

Terminal to MODEM Interface Operation

Figure 5

Prior to the 1960's nearly all telephone lines or private lines were carried on land-lines, which are wires strung along poles with cross arms using glass insulators for attaching the wires. This was not the most trouble free environment. In the 1960's and later cross-country Microwave systems were implemented, followed by satellites, copper wire cable systems and fiber optic cable systems. And, of course the present wireless communications, cell phones, Personal Digital Assistant (PDA) and others.

The term 'broadband' was used in the past to define any bit per second (bps) rate of 2400 bps to 9600 bps. In the world of today the term broadband (multiple voice grade channel frequencies) is used to define much higher bps rates. For instance today the 56.6 kbps (thousand bit per second) MODEM is

MODEM History Overview

By Bob Pollard

presently used for communicating on the WWW (World Wide Web) via a standard dial up line, which is not considered a 'broadband' channel. Although due to bandwidth limitations, noise, distortion, bias, a mismatched MODEM and other factors on dial up lines, the bps transfer rate on average falls between 14 and 50 kbps rather than the designated 56.6 kbps rate.

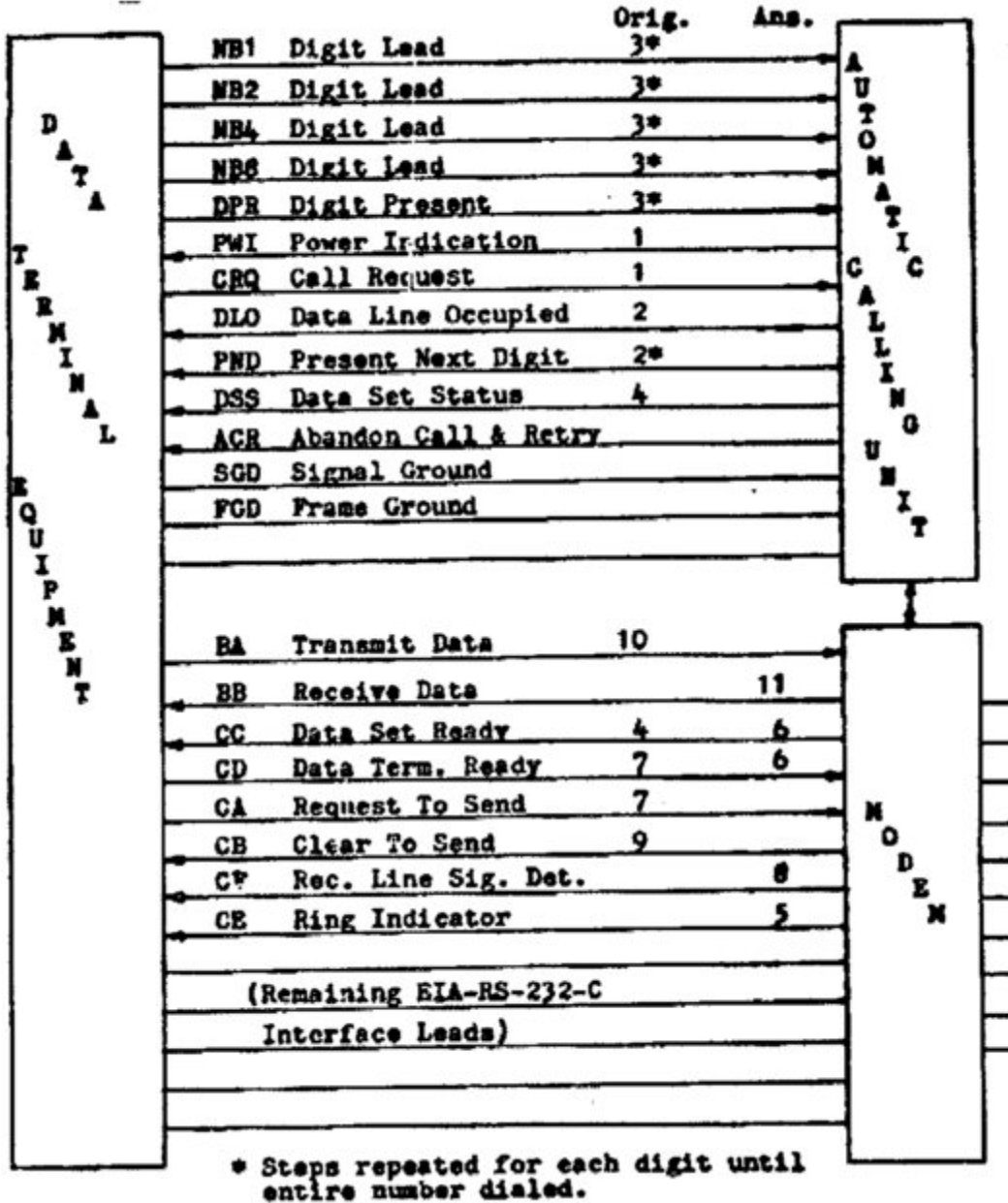

Terminal to Automatic Calling Unit operation
Figure 6

It should be noted that when referring to 'broadband' the term broadband does not necessarily imply that the broadband frequencies must be a multiple of voice grade channels (lines), but in many cases bundling of voice grade channels is the norm. In reality broadband is a term used to identify any bandwidth frequency greater than 4000 Hz (cycles).

MODEM History Overview

By Bob Pollard

The MODEM RS-232 standard, with a few modifications to level 'C', has been in use since the 1960's, and in addition to new standards developed (RS-449) for networks, Packet switching and Internet protocols, RS-232 is still a basic standard today.

Of course any inventor or manufacturer can design their particular MODEM to use an undisclosed modulation technique and personally modified logical control functions. Of course this action can create a problem of compatibility between dissimilar MODEM(s) on each end.