



# Internet History and Growth

William F. Slater, III

Chicago Chapter of the Internet Society

September 2002



# Agenda

- Internet History
- Internet Evolution
- Internet Pioneers
- Internet Growth - Sept. 1969 - Sept. 2002
- Conclusion



What Was the  
“Victorian Internet”?

# What Was the “Victorian Internet”

- The Telegraph
- Invented in the 1840s.
- Signals sent over wires that were established over vast distances
- Used extensively by the U.S. Government during the American Civil War, 1861 - 1865
- Morse Code was dots and dashes, or short signals and long signals
- The electronic signal standard of +/- 15 v. is still used in network interface cards today.



# Famous Quote From Sir Isaac Newton

- “If I have been able to see farther than others, it was because I stood on the shoulders of giants.”



# What Is the Internet?

- A network of networks, joining many government, university and private computers together and providing an infrastructure for the use of E-mail, bulletin boards, file archives, hypertext documents, databases and other computational resources
- The vast collection of computer networks which form and act as a single huge network for transport of data and messages across distances which can be anywhere from the same office to anywhere in the world.

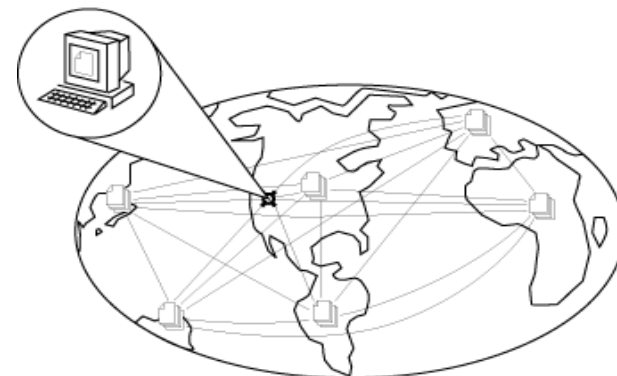

Written by William F. Slater, III

1996

President of the Chicago Chapter of the Internet Society

# What is the Internet?



- The largest network of networks in the world.
- Uses TCP/IP protocols and packet switching .
- Runs on any communications substrate.

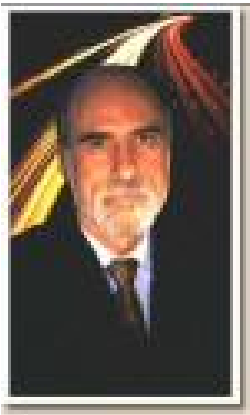

From Dr. Vinton Cerf,  
Co-Creator of TCP/IP



# Brief History of the Internet

- 1968 - DARPA (Defense Advanced Research Projects Agency) contracts with BBN (Bolt, Beranek & Newman) to create ARPAnet
- 1970 - First five nodes:
  - UCLA
  - Stanford
  - UC Santa Barbara
  - U of Utah, and
  - BBN
- 1974 - TCP specification by Vint Cerf
- 1984 - On January 1, the Internet with its 1000 hosts converts en masse to using TCP/IP for its messaging

# \*\*\* Internet History \*\*\*

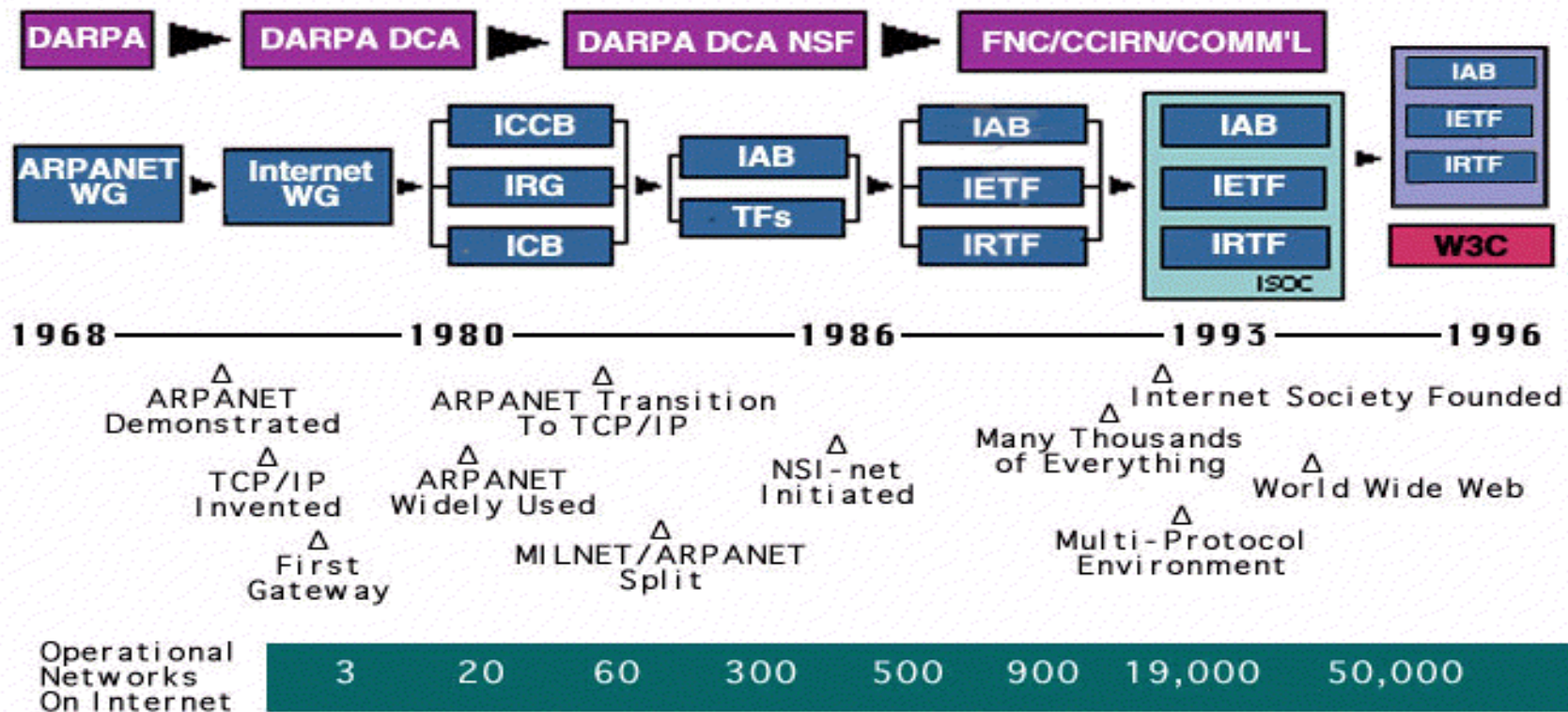

# A Brief Summary of the Evolution of the Internet

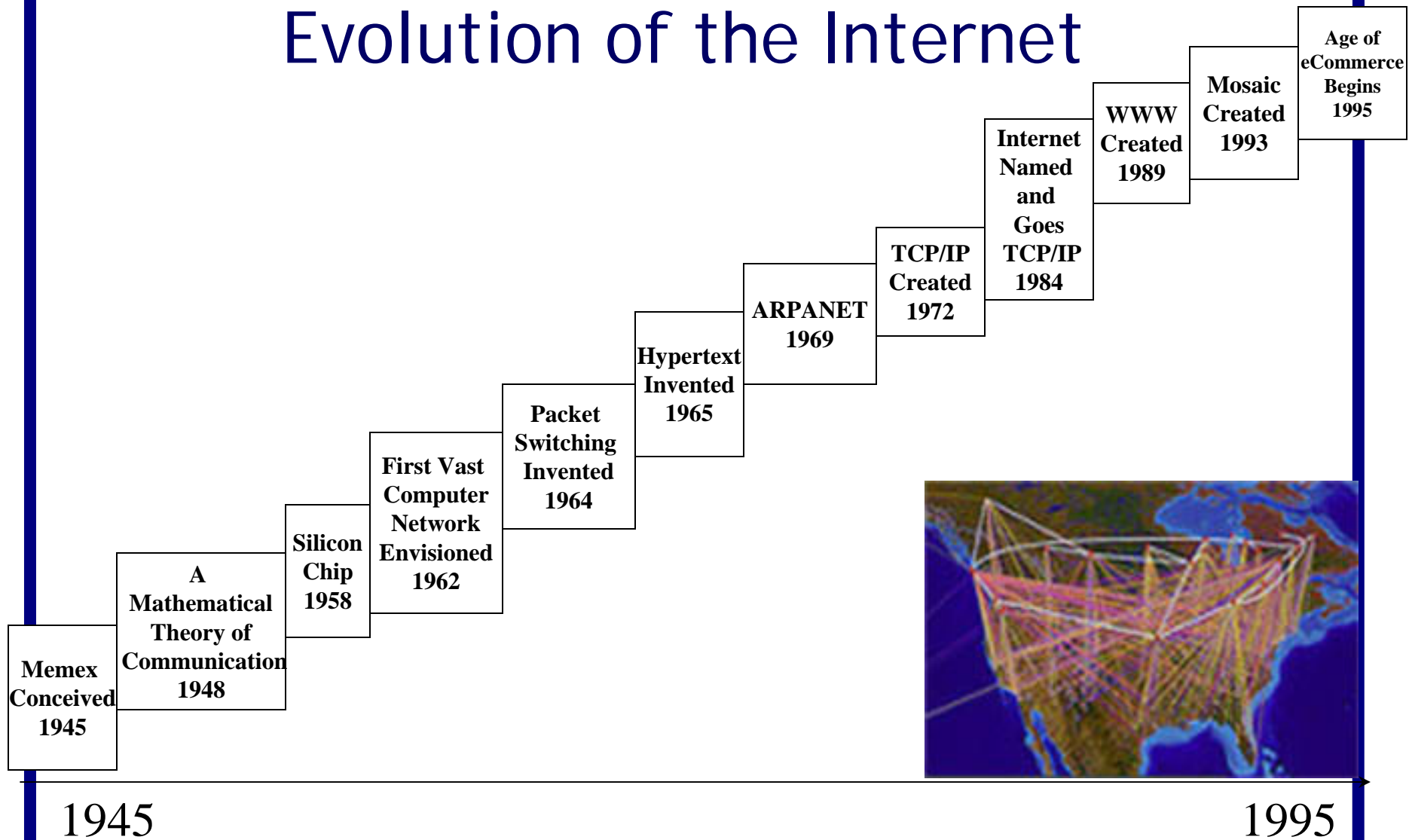

# From Simple, But Significant Ideas Bigger Ones Grow

## 1940s to 1969

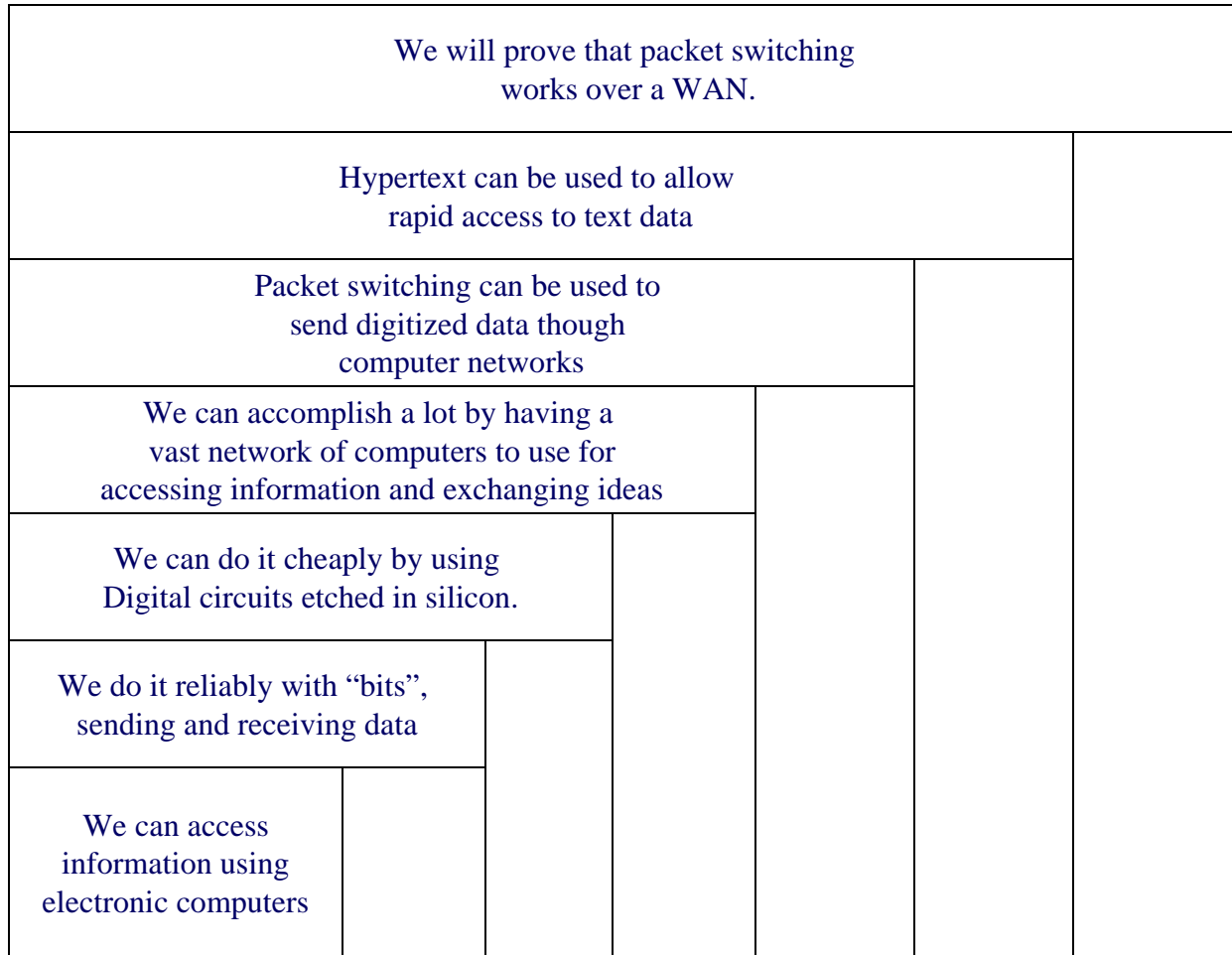

1945

1969



# From Simple, But Significant Ideas Bigger Ones Grow 1970s to 1995

Great efficiencies can be accomplished if we use The Internet and the World Wide Web to conduct business.				
The World Wide Web is easier to use if we have a browser that To browser web pages, running in a graphical user interface context.				
Computers connected via the Internet can be used more easily if hypertext links are enabled using HTML and URLs: it's called World Wide Web				
The ARPANET needs to convert to a standard protocol and be renamed to The Internet				
We need a protocol for Efficient and Reliable transmission of Packets over a WAN: TCP/IP				
Ideas from 1940s to 1969				

1970

1995



# The Creation of the Internet

- The creation of the Internet solved the following challenges:
  - Basically inventing digital networking as we know it
  - Survivability of an infrastructure to send / receive high-speed electronic messages
  - Reliability of computer messaging



# Tribute to the Internet Pioneers

- The Internet we know and love today, would not exist without the hard work of a lot of bright people.
- The technologies and standards they created make today's Internet and World Wide Web possible.
- They deserve recognition and our gratitude for changing the world with the Internet.
- In this presentation, we will identify and pay tribute to several of the people who made the Internet and the World Wide Web possible

# Internet Pioneers in this Presentation

Vannevar Bush	Claude Shannon	J. C. R. Licklider
Paul Baran	Ted Nelson	Leonard Kleinrock
Lawrence Roberts	Steve Crocker	Jon Postel
Vinton Cerf	Robert Kahn	Christian Huitema
Brian Carpenter	Tim Berners-Lee	Mark Andreessen

# Vannevar Bush

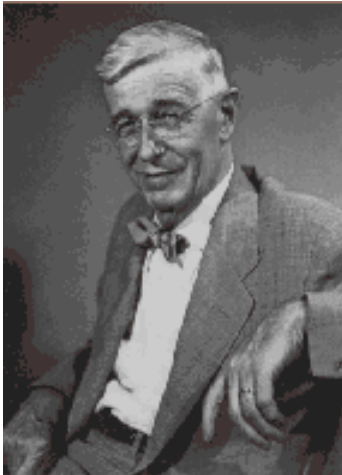

- *Summary:* Vannevar Bush established the U.S. military / university research partnership that later developed the *ARPANET*. He also wrote the first visionary description of the potential use for information technology, inspiring many of the Internet's creators.
- President Roosevelt appointed Bush to Chairman of the National Defense Research Committee in 1940 to help with World War II.
- In 1941, Bush was appointed Director of the newly created "Office of Scientific Research and Development", established to coordinate weapons development research. The organization employed more than 6000 scientists by the end of the war, and supervised development of the atom bomb.
- From 1946 to 1947, Bush served as chairman of the Joint Research and Development Board. Out of this effort would later come DARPA, which would later do the ARPANET Project.

## Quote:

- "Consider a future device for individual use, which is a sort of mechanized private file and library. It needs a name, and to coin one at random, "memex" will do. A memex is a device in which an individual stores all his books, records, and communications, and which is mechanized so that it may be consulted with exceeding speed and flexibility. It is an enlarged intimate supplement to his memory.
- It consists of a desk, and while it can presumably be operated from a distance, it is primarily the piece of furniture at which he works. On the top are slanting translucent screens, on which material can be projected for convenient reading. There is a keyboard, and sets of buttons and levers. Otherwise it looks like an ordinary desk.
  - Vannevar Bush; *As We May Think*; Atlantic Monthly; July 1945

# Claude Shannon

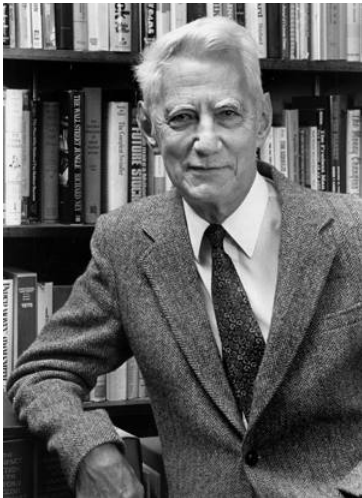

- ***The Father of Modern Information Theory***
- Published a "A Mathematical Theory of Communication" in 1948: Before Shannon, it was commonly believed that the only way of achieving arbitrarily small probability of error in a communication channel was to reduce the transmission rate to zero. All this changed in 1948 with the publication of A Mathematical Theory of Communication, where Shannon characterized a channel by a single parameter; the channel capacity, and showed that it was possible to transmit information at any rate below capacity with an arbitrarily small probability of error. His method of proof was to show the existence of a single good code by averaging over all possible codes. His paper established fundamental limits on the efficiency of communication over noisy channels, and presented the challenge of finding families of codes that achieve capacity. The method of random coding does not produce an explicit example of a good code, and in fact it has taken fifty years for coding theorists to discover codes that come close to these fundamental limits on telephone line channels.
- Created the idea that all information could be represented using 1s and 0s. Called these fundamental units BITS.
- Created the concept data transmission in BITS per second.
- Won a Nobel prize for his master's thesis in 1936, titled, "A Symbolic Analysis of Relay and Switching Circuits", it provided mathematical techniques for building a network of switches and relays to realize a specific logical function, such as a combination lock.

# J. C. R. Licklider



- **Summary:** Joseph Carl Robnett "Lick" Licklider developed the idea of a universal network, spread his vision throughout the *IPTO*, and inspired his successors to realize his dream by creation of the *ARPANET*. He also developed the concepts that led to the idea of the *Netizen*.
- Licklider also realized that interactive computers could provide more than a library function, and could provide great value as automated assistants. He captured his ideas in a seminal paper in 1960 called *Man-Computer Symbiosis*, in which he described a computer assistant that could answer questions, perform simulation modeling, graphically display results, and extrapolate solutions for new situations from past experience. Like *Norbert Wiener*, Licklider foresaw a close symbiotic relationship between computer and human, including sophisticated computerized interfaces with the brain.
- Quote:
- It seems reasonable to envision, for a time 10 or 15 years hence, a 'thinking center' that will incorporate the functions of present-day libraries together with anticipated advances in information storage and retrieval.
- The picture readily enlarges itself into a network of such centers, connected to one another by wide-band communication lines and to individual users by leased-wire services. In such a system, the speed of the computers would be balanced, and the cost of the gigantic memories and the sophisticated programs would be divided by the number of users.
- - J.C.R. Licklider, *Man-Computer Symbiosis*, 1960.

# Paul Baran



- **Summary:** Paul Baran developed the field of *packet switching* networks while conducting research at the historic RAND organization.
- In 1959, a young electrical engineer named Paul Baran joined RAND from Hughes Aircraft's systems group. The US Air Force had recently established one of the first wide area computer networks for the *SAGE* radar defence system, and had an increasing interest in survivable, wide area communications networks so they could reorganize and respond after a nuclear attack, diminishing the attractiveness of a first strike option by the Soviet Union.
- Baran began an investigation into development of survivable communications networks, the results of which were first presented to the Air Force in the summer of 1961 as briefing B-265, then as paper P-2626, and then as a series of eleven comprehensive papers titled *On Distributed Communications* in 1964.
- Baran's study describes a remarkably detailed architecture for a distributed, survivable, packet switched communications network. The network is designed to withstand almost any degree of destruction to individual components without loss of end-to-end communications. Since each computer could be connected to one or more other computers, it was assumed that any link of the network could fail at any time, and the network therefore had no central control or administration.
- Baran's architecture was well designed to survive a nuclear conflict, and helped to convince the US Military that wide area digital computer networks were a promising technology. Baran also talked to Bob Taylor and *J.C.R. Licklider* at the *IPTO* about his work, since they were also working to build a wide area communications network. His 1964 series of papers then influenced *Roberts* and *Kleinrock* to adopt the technology for development of the *ARPANET* network a few years later, laying the groundwork that leads to its continued use today.
- Baran has also received several awards, including the IEEE Alexander Graham Bell Medal, and the Marconi International Fellowship Award.

# Ted Nelson



Xanadu Logo

- Ted Nelson is a somewhat controversial figure in the computing world. For thirty-something years he has been having grand ideas but has never seen them through to completed projects. His biggest project, Xanadu, was to be a world-wide electronic publishing system that would have created a sort universal library for the people. He is known for coining the term "hypertext." He is also seen as something of a radical figure, opposing authority and tradition. He has been called "one of the most influential contrarians in the history of the information age." (Edwards, 1997). He often repeats his four maxims by which he leads his life: "most people are fools, most authority is malignant, God does not exist, and everything is wrong." (Wolf, 1995)
- **Xanadu**
- Nelson continued to expound his ideas, but he did not possess the technical knowledge to tell others how his ideas could be implemented, and so many people simply ignored him (and have ever since). Still, Nelson persisted. In 1967, he named his system XANADU, and with the help of interested, mainly younger, computer hacks continued to develop it.
- Xanadu was conceived as a tool to preserve and increase humanity's literature and art. Xanadu would consist of a world-wide network that would allow information to be stored not as separate files but as connected literature. Documents would remain accessible indefinitely. Users could create virtual copies of any document. Instead of having copyrighted materials, the owners of the documents would be automatically paid via electronic means a micropayment for the virtual copying of their documents.
- Xanadu has never been totally completed and is far from being implemented. In many ways Tim Berners-Lee's World Wide Web is a similar, though much less grand, system. In 1999, the Xanadu code was made open source.

# Leonard Kleinrock



- *Summary:* Leonard Kleinrock is one of the pioneers of digital network communications, and helped build the early ARPANET.
- Kleinrock published his first paper on digital network communications, Information Flow in Large Communication Nets, in the RLE Quarterly Progress Report, in July, 1961. He developed his ideas further in his 1963 Ph.D. thesis, and then published a comprehensive analytical treatment of digital networks in his book Communication Nets in 1964.
- After completing his thesis in 1962, Kleinrock moved to UCLA, and later established the Network Measurement Center (NMC), led by himself and consisting of a group of graduate students working in the area of digital networks. In 1966, Roberts joined the IPTO with a mandate to develop the ARPANET, and used Kleinrock's Communication Nets to help convince his colleagues that a wide area digital communication network was possible. In October, 1968, Roberts gave a contract to Kleinrock's NMC as the ideal group to perform ARPANET performance measurement and find areas for improvement.
- On a historical day in early September, 1969, a team at Kleinrock's NMC connected one of their SDS Sigma 7 computers to an Interface Message Processor, thereby becoming the first node on the ARPANET, and the first computer ever on the Internet.
- As the ARPANET grew in the early 1970's, Kleinrock's group stressed the system to work out the detailed design and performance issues involved with the world's first packet switched network, including routing, loading, deadlocks, and latency. The UCLA Netwatch program now performs similar functions to Kleinrock's Network Management Center from the ARPANET years.
- Kleinrock has continued to be active in the research community, and has published more than 200 papers and authored six books. In August, 1989, he organized and chaired a symposium commemorating the 20'th anniversary of the ARPANET, which later produced the document RFC 1121, titled "Act One -- The Poems".

# Lawrence Roberts



- **Summary:** Lawrence Roberts was the *ARPANET* program manager, and led the overall system design.
- Lawrence Roberts obtained his B.S., M.S., and Ph.D. degrees from MIT, and then joined the Lincoln Laboratory, where he carried out research into computer networks. In a pivotal meeting in November, 1964, Roberts met with *J.C.R. Licklider*, who inspired Roberts with his dream to build a wide area communications network.
- In February, 1965, the director of the *IPTO*, Ivan Sutherland, gave a contract to Roberts to develop a computer network. In July, Roberts gave a contract to Thomas Marill, who had also been inspired by Licklider, to program the network. In October, 1965, the Lincoln Labs TX-2 computer talked to their SDC's Q32 computer in one of the worlds first digital network communications.
- In October, 1966, Roberts and Marill published a paper titled *Toward a Cooperative Network of Time-Shared Computers* at the Fall AFIPS Conference, documenting their networking experiments.
- Also in 1966, *DARPA* head Charlie Hertzfeld promised IPTO Director Bob Taylor a million dollars to build a distributed communications network if he could get it organized. Taylor was greatly impressed by Lawrence Roberts work, and asked him to come on board to lead the effort. Roberts resisted at first, and then joined as ARPA IPTO Chief Scientist in December 1966 when Taylor brought pressure on him through Hertzfeld and his boss at the Lincoln Lab. Roberts then immediately started working on the system design for a wide area digital communications network that would come to be called the ARPANET.
- In April, 1967, Roberts held an "ARPANET Design Session" at the IPTO Principal Investigator meeting in Ann Arbor, Michigan. The standards for identification and authentication of users, transmission of characters, and error checking and retransmission procedures were outlined at this meeting, and it was at this meeting that Wesley Clark suggested using a separate minicomputer called the *Interface Message Processor* to interface to the network.

# Lawrence Roberts



- Roberts presented a paper called *Multiple Computer Networks and Intercomputer Communication* that summarized the ARPANET plan at the ACM Symposium on Operating System Principles at Gatlinburg, Tennessee, in October 1967. He then wrote a program plan called "Resource Sharing Computer Networks" to build a working implementation of the network. The project justified itself, in part, by arguing that different departments would be able to log into other computers and use their programs remotely, thereby saving the costs of buying or building programs themselves, and greatly expanding the capabilities available to each site on the network. He gave the report to Taylor on June 3, 1968, who approved it on June 21. The work was begun.
- Roberts also hired the developer of TCP/IP, *Bob Kahn*, who had worked on the Interface Message Processor at BBN.
- Roberts became Director of the IPTO when Taylor left in September, 1969. Roberts left the IPTO in October, 1973, to become CEO of Telenet, the first packet switching network carrier, which later standardized on the X.25 networking system originally used on the *EUnet*. Roberts later left Telenet when it was sold to GTE in 1979 and became the data division of Sprint.
- In 1982, Roberts was President and CEO of DHL. From 1983 to 1993, he was Chairman and CEO of NetExpress, Inc., an electronics company specializing in packetized facsimile and ATM equipment. From 1993 to 1998, he was President of networking company ATM Systems. In the late 1990's, Roberts was Chairman and CTO of Packetcom, specializing in advanced Internet routers with improved quality of service.
- Roberts has received numerous awards for his work, including the Secretary of Defense Meritorious Service Medal, the Harry Goode Memorial Award from the American Federation of Information Processing, the IEEE Computer Pioneer Award, the Interface Conference Award, the L.M. Ericsson prize for research in data communications in 1982, the IEEE Computer Society W. Wallace McDowell Award in 1992, and the ACM SIGCOMM communications award in 1998.

# Steve Crocker



- *DR. STEPHEN D. CROCKER* CEO, Steve Crocker Associates, LLC and Executive DSL, LLC [steve@stevetrocker.com](mailto:steve@stevetrocker.com)
- Steve Crocker is an Internet and computer security expert. Steve Crocker Associates, LLC is a consulting and R&D company specializing in current Internet and electronic commerce technologies. Executive DSL, LLC is an ISP specializing in the integration of Internet-based services for small and medium businesses.
- Steve Crocker was one of the founders and chief technology officer of CyberCash, Inc., the leading Internet payments company. In the late 1960s and early 1970s, Dr. Crocker was part of the team which developed the protocols for the Arpanet and laid the foundation for today's Internet. In addition to his technical work on the early protocols, he organized the Network Working Group, which was the forerunner of the modern Internet Engineering Task Force, and he initiated the Request for Comment (RFC) series of notes through which protocol designs are documented and shared. And wrote many of the first RFCs, including RFC 1 and 3.
- Dr. Crocker has been a program manager at Advanced Research Projects Agency (ARPA), a senior researcher at USC's Information Sciences Institute, founder and director of the Computer Science Laboratory at the Aerospace Corporation and a vice president at Trusted Information Systems before joining CyberCash. Dr. Crocker served as the area director for security in the Internet Engineering Task Force for four years and as a member of the Internet Architecture Board for two years. Dr. Crocker holds a B.A. in mathematics and a Ph.D. in Computer Science from UCLA.

# Jon Postel

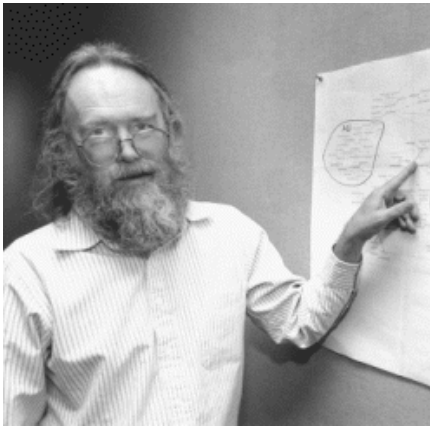

- From Jon Postel's Bio:
- Jon Postel is the Director of ISI's Computer Networks Division. The division has 70 staff members working on about 10 projects, including the NSF sponsored Routing Arbiter, and DARPA sponsored projects in the areas of Active Networks, Middleware, Security, Distributed Systems, and High Speed Networking.
- He received his B.S. and M.S. in Engineering, and his Ph.D. in Computer Science from UCLA, in 1966, 1968, and 1974 respectively. Jon is a member of the ACM and the Internet Society (and currently serves on the Internet Society Board of Trustees).
- At UCLA he was involved in the beginnings of the ARPANET and the development of the Network Measurement Center.
- He has worked in the areas of computer communication protocols, especially at the operating system level and the application level.
- His current interests include multi-machine internetwork applications, multimedia conferencing and electronic mail, very large networks, and very high speed communications.
- Jon is also involved in several Internet infrastructure activities including the Internet Assigned Numbers Authority, the RFC Editor, the US Domain, and the Los Nettos network (a regional network for the greater Los Angeles area).
- Jon was regarded by many to be the 'policeman of Internet Standards' for many years during the infancy of the Internet.
- Jon was honored by Dr. Vint Cerf in October 1998, shortly after his passing with the addition of RFC 2468.

# Vinton Cerf

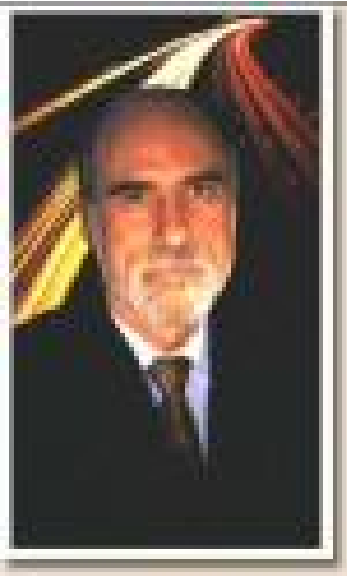

- **Summary:** Vinton Cerf is co-designer of the *TCP/IP* networking protocol.
- In 1972, Vinton Cerf was a *DARPA* scientist at Stanford University when he was appointed chairman of the InterNetworking Working Group (INWG), which had just been created with a charter to establish common technical standards to enable any computer to connect to the *ARPANET*. The INWG later became affiliated with the International Federation of Information Processing (IFIP), and has since been known as IFIP Working Group 1 of Technical Committee 6.
- Cerf worked on several interesting networking projects at DARPA, including the Packet Radio Net (PRNET), and the Packet Satellite Network (SATNET). In the spring of 1973, he joined *Bob Kahn* as Principal Investigator on a project to design the next generation networking protocol for the ARPANET. Kahn had experience with the *Interface Message Processor*, and Cerf had experience with the *Network Control Protocol*, making them the perfect team to create what became TCP/IP.
- Cerf and Kahn started by drafting a paper describing their network design, titled "A Protocol for Packet Network Interconnection", which they distributed at a special meeting of the INWG at Sussex University in September, 1973, and then finalized and published in the *IEEE Transactions of Communications Technology*, in May, 1974.
- Cerf and Stanford graduate students Yogen Dalal and Carl Sunshine published the first technical specification of TCP/IP as an Internet Experiment Note (*IEN*) as RFC 675, in December, 1974. Their design included a 32 bit *IP address*, with eight bits for identification of a network, and 24 bits for identification of a computer, which provided support for up to 256 networks, each with up to 16,777,216 unique network addresses.

# Vinton Cerf

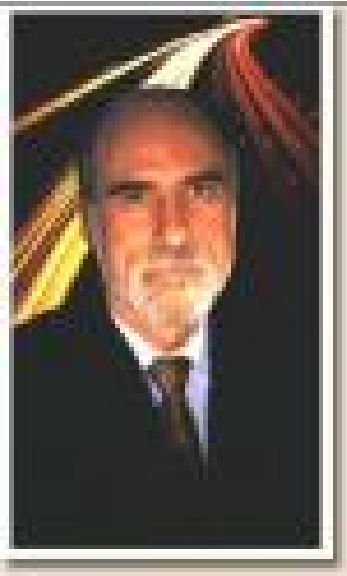

- It was assumed that the network design would eventually be re-engineered for a production system, but the architecture proved remarkably robust -- Cerf has said that once the network was developed and *deployed*, it just "continued to spread without stopping!"
- Cerf has continued to perform research and contribute to the development of the Internet through work with the communications company WorldCom and the Internet management organization ICANN.
- **Resources.** Cerf is the author of three *entertaining RFCs* and contributed to a fourth:
  - RFC 968; "Twas the Night Before Start-up"; December, 1985.
  - RFC 1121; Leonard Kleinrock, Vinton Cerf, Barry Boehm; "Act One -- The Poems", presented at the Act One symposium held on the 20th anniversary of the ARPANET, published September 1989.
  - RFC 1217; "Memo from the Consortium for Slow Commotion Research (CSCR)"; April 1st, 1991; in response to RFC 1216.
  - RFC 1607; "A View From The 21st Century"; April 1st, 1994.
- Other online publications by Cerf are listed below:
  - How the Internet Came to Be.
  - A Brief History of the Internet and Related Networks.
  - Internet: Past, Present, and Future.
- Dr. Cerf is a tireless advocate and speaker, educating people about the history of the Internet, Internet Technologies, the effects of the Internet on Society, and on how the Internet will affect the future of things like space travel and communications.
- He is also a founder of the Internet Society and its former Chairman.

# Robert Kahn



- **Summary:** Bob Kahn is co-designer of the *TCP/IP* networking protocol.
- Robert Kahn obtained a Ph.D. degree from Princeton University in 1964, worked for a while at AT&T Bell Laboratories, and then became an Assistant Professor of Electrical Engineering at MIT. He later went to work at Bolt Beranek and Newman, and helped build the *Interface Message Processor*.
- In 1972, Kahn was hired by *Lawrence Roberts* at the *IPTO* to work on networking technologies, and in October he gave a demonstration of an *ARPANET* network connecting 40 different computers at the International Computer Communication Conference, making the network widely known for the first time to people from around the world.
- Kahn then began work on development of a standard open-architecture network model, where any computer could communicate with any other, independent of individual hardware and software configuration. He set four goals for the TCP design:
- **Network Connectivity.** Any network could connect to another network through a gateway.
- **Distribution.** There would be no central network administration or control.
- **Error Recovery.** Lost packets would be retransmitted.
- **Black Box Design.** No internal changes would have to be made to a computer to connect it to the network.
- In the spring of 1973, *Vinton Cerf* joined Kahn on the project. They started by conducting research on reliable data communications across packet radio networks, and then studied the *Networking Control Protocol*, building on it to create the Transmission Control Protocol (TCP).
- TCP had powerful error and retransmission capabilities, and provided extremely reliable communications. It was subsequently layered into two protocols, TCP/IP, where TCP handles high level services like retransmission of lost packets, and IP handles packet addressing and transmission.

# Robert Kahn



- Kahn has continue to nurture the development of the Internet over the years through shepherding the standards process and related activities, and is now President of the Corporation for National Research Initiatives (CNRI), a not-for-profit organization which performs research in the public interest on strategic development of network-based information technologies.
- **Resources.** The following publications provide additional information:
- Chapter 2- The Role of Government in the Evolution of the Internet; Revolution in the U.S. Information Infrastructure; National Academy of Sciences; 1994.
- RFC 6; Conversation With Bob Kahn; 10 April, 1969.

# Christian Huitema



- Christian Huitema joined Microsoft in February 2000, as "architect" in the "Windows Networking & Communications" group. The group is in charge of all the networking support for Windows, including the evolution of TCP/IP support, IPv6, Real-Time Communication, and Universal Plug and Play (UPnP). Prior to joining Microsoft, he was chief scientist, and Telcordia Fellow, in the Internet Architecture Research laboratory of Telcordia, working on Internet Quality of Service and Internet Telephony. The work on Internet Telephony led to the development of the "Call Agent Architecture" that enables very large scale configuration, moving Internet telephony into the main stream of telecommunications. His personal work on quality of service focused on measurement of the Internet's size and quality.
- Huitema joined Bellcore (now Telcordia) the 18 March 1996. From 1986 to 1996, he led the research project RODEO at INRIA in Sophia-Antipolis, France. He worked there on the definition and the experimentation of innovative communication protocols, software and compilers. One of the results was the IP based H.261 videoconferencing system, IVS, with which we demonstrated in 1994 that video communication can be made Internet friendly.
- From 1980 to 1985, he worked at CNET (Centre National d'Etudes des Télécommunications), investigating computer usage of telecommunication satellites -- this was the subject of his doctorate thesis. He worked then on a joined project between CNET and INRIA, where he developed communication protocols for the SM90 workstation.
- Between 1975 and 1980, he worked as a software engineer at SEMA, first porting large Fortran programs to new architecture and then developing large Cobol applications for manufacture control.
- He studied at the Ecole Polytechnique in Paris from 1972 to 1975, and obtained in 1985 a Doctorat ès Sciences from the Université Pierre et Marie Curie (Paris 6).
- Huitema was a member of the Internet Architecture Board (IAB) from 1991 to 1996, its chair between April 1993 and July 1995. He was elected a trustee of the Internet Society in May 1995.
- Huitema has written a fairly large number of scientific publications, articles and conference communications, as well as three books, "Routing in the Internet" (Prentice-Hall PTR, 1995), "IPv6, the new Internet Protocol" (Prentice-Hall PTR, 1996) and "Et Dieu créa l'Internet" (Eyrolles, 1995).

# Brian Carpenter



- Brian Carpenter has a PhD in computer science. Worked 1975-85 developing process control systems at CERN in Geneva, taught computer science at Massey University in New Zealand, and was Communications Systems group leader at CERN from 1985-1998. He moved to an IBM software development group in Hursley Park in the UK where he appears to principally pursue IETF/IAB activities along with assisting IBM's Internet 2 applications development efforts. He has involved for some years in Internet Society activities. He also served as chair of the IAB prior to Baker.
- Brian has recently worked on the IPv6 Task Force, as well as the Internet Architecture Board and the Internet Engineering Task Force. His interests include IPv6 IP Security and Quality of Service.
- Brian is currently the Chairman of the Internet Society.
- He spoke to the members of ISOC-Chicago in May 2001 at Northwestern University.

# Tim Berners-Lee



- **The inventor of HTML.** Graduate of Oxford University, England, Tim is now with the Laboratory for Computer Science (LCS) at the Massachusetts Institute of Technology (MIT).
- He directs the W3 Consortium, an open forum of companies and organizations with the mission to realize the full potential of the Web.
- With a background of system design in real-time communications and text processing software development, in 1989 he invented the World Wide Web, an internet-based hypermedia initiative for global information sharing, while working at CERN, the European Particle Physics Laboratory.
- Before coming to CERN, Tim was a founding director of Image Computer Systems, and before that a principal engineer with Plessey Telecommunications, in Poole, England.

# Mark Andreessen

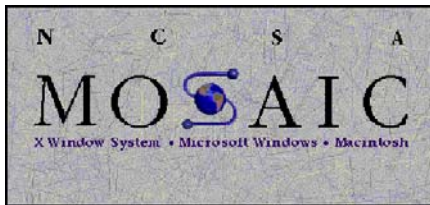

- Marc Andreessen was a student and part-time assistant at the National Center for Supercomputing Applications (NCSA) at the University of Illinois when the World Wide Web began to take off. His position at NCSA allowed him to become very familiar with the Internet. Like just about everyone else who was involved with the Internet, he also became familiar with the Web. Most of the browsers available then were for Unix machines which were expensive. This meant that the Web was mostly used by academics and engineers who had access to such machines. The user-interfaces of available browsers also tended to be not very user-friendly, which also hindered the spread of the Web. Marc decided to develop a browser that was easier to use and more graphically rich.
- In 1992, Andreessen recruited fellow NCSA employee, Eric Bina, to help with his project. The two worked tirelessly. Bina remembers that they would 'work three to four days straight, then crash for about a day' ([Reid, 7](#)). They called their new browser Mosaic. It was much more sophisticated graphically than other browsers of the time. Like other browsers it was designed to display HTML documents, but new formatting tags like "center" were included.
- Especially important was the inclusion of the "image" tag which allowed to include images on web pages. Earlier browsers allowed the viewing of pictures, but only as separate files. Mosaic made it possible for images and text to appear on the same page. Mosaic also sported a graphical interface with clickable buttons that let users navigate easily and controls that let users scroll through text with ease. Another innovative feature was the hyper-link. In earlier browsers hypertext links had reference numbers that the user typed in to navigate to the linked document. Hyper-links allowed the user to simply click on a link to retrieve a document.

# Mark Andreessen

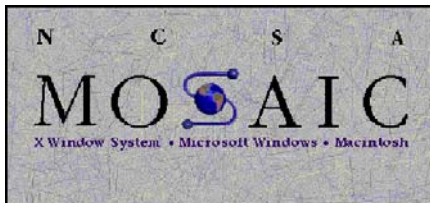

- In early 1993, Mosaic was posted for download on NCSA's servers. It was immediately popular. Within weeks tens of thousands of people had downloaded the software. The original version was for Unix. Andreessen and Bina quickly put together a team to develop PC and Mac versions, which were released in the late spring of the same year. With Mosaic now available for more popular platforms, its popularity skyrocketed. More users meant a bigger Web audience. The bigger audiences spurred the creation of new content, which in turn further increased the audience on the Web and so on. As the number of users on the Web increased, the browser of choice was Mosaic so its distribution increased accordingly.
- By December 1993, Mosaic's growth was so great that it made the front page of the New York Times business section. The article concluded that Mosaic was perhaps "an application program so different and so obviously useful that it can create a new industry from scratch" ([Reid, 17](#)). NCSA administrators were quoted in the article, but there was no mention of either Andreessen or Bina. Marc realized that when he was through with his studies NCSA would take over Mosaic for themselves. So when he graduated in December 1993, he left and moved to Silicon Valley in California.

# Mark Andreessen

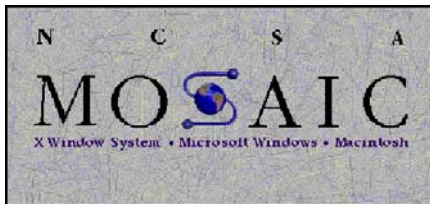

- Netscape
- Andreessen settled in Palo Alto, and soon met Jim Clark. Clark had founded Silicon Graphics, Inc. He had money and connections. The two began talking about a possible new start-up company. Others were brought into the discussions and it was decided that they would start an Internet company. Marc contacted old friends still working for NCSA and enticed a group of them to come be the engineering team for the new company. In mid-1994, Mosaic Communications Corp. was officially incorporated in Mountain View, California. Andreessen became the Vice President of Technology of the new company.
- The new team's mandate was to create a product to surpass the original Mosaic. They had to start from scratch. The original had been created on university time with university money and so belonged exclusively to the university. The team worked furiously. One employee recalls, "a lot of times, people were there straight forty-eight hours, just coding. I've never seen anything like it, in terms of honest-to-God, no BS, human endurance, to sit in front of a monitor and program. But they were driven by this vision [of beating the original Mosaic]" (Reid, 27).
- The new product would need a name. Eventually, the name Netscape was adopted.
- In November of 1998, Netscape was bought by AOL.
- Today, Marc Andreessen is VP of LoudCloud.com

# Honorable Mention



Jack Kilby



Robert Noyce



Esther Dyson



Bob Metcalfe

- Jack Kilby
  - Co-inventor of the silicon microchip
- Robert Noyce
  - Co-inventor of the silicon microchip
- Robert Metcalfe
  - ARPANET engineer and inventor of Ethernet, and founder of 3Com
- Esther Dyson
  - Visionary who helped start the Electronic Frontier Foundation, and who was the first Chairman of ICANN at its beginning in October 1998.

# Internet Growth Trends

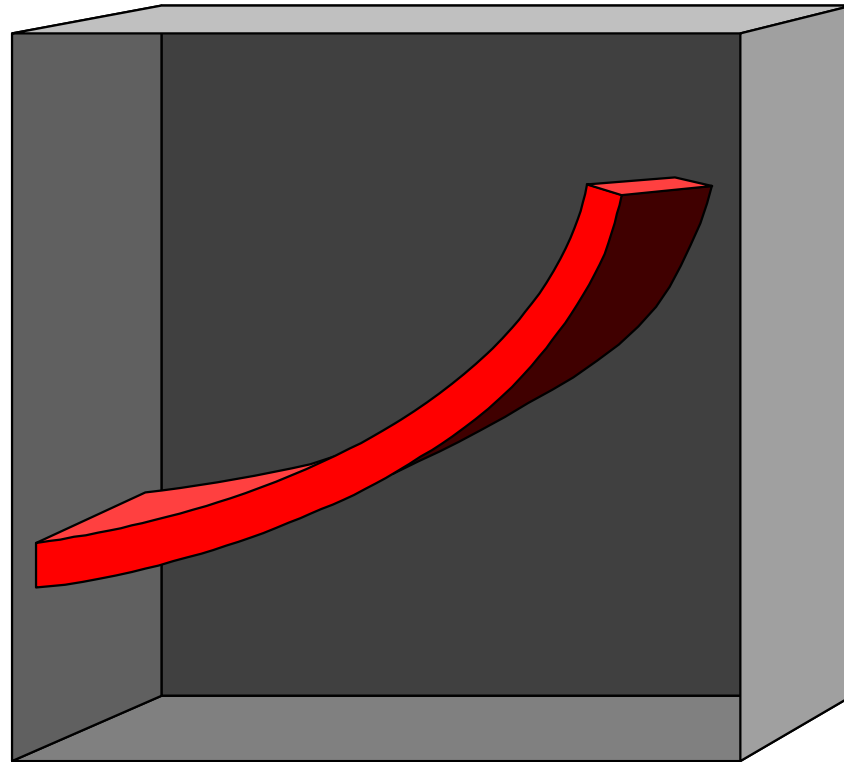

# Internet Growth Trends

- 1977: 111 hosts on Internet
- 1981: 213 hosts
- 1983: 562 hosts
- 1984: 1,000 hosts
- 1986: 5,000 hosts
- 1987: 10,000 hosts
- 1989: 100,000 hosts
- 1992: 1,000,000 hosts
- 2001: 150 - 175 million hosts
- 2002: over 200 million hosts
- By 2010, about 80% of the planet will be on the Internet

# No. of Participating Hosts Oct. '90 - Apr. '98

Hobbes' Internet Timeline Copyright ©1998 Robert H Zakon  
<http://www.isoc.org/zakon/Internet/History/HIT.html>

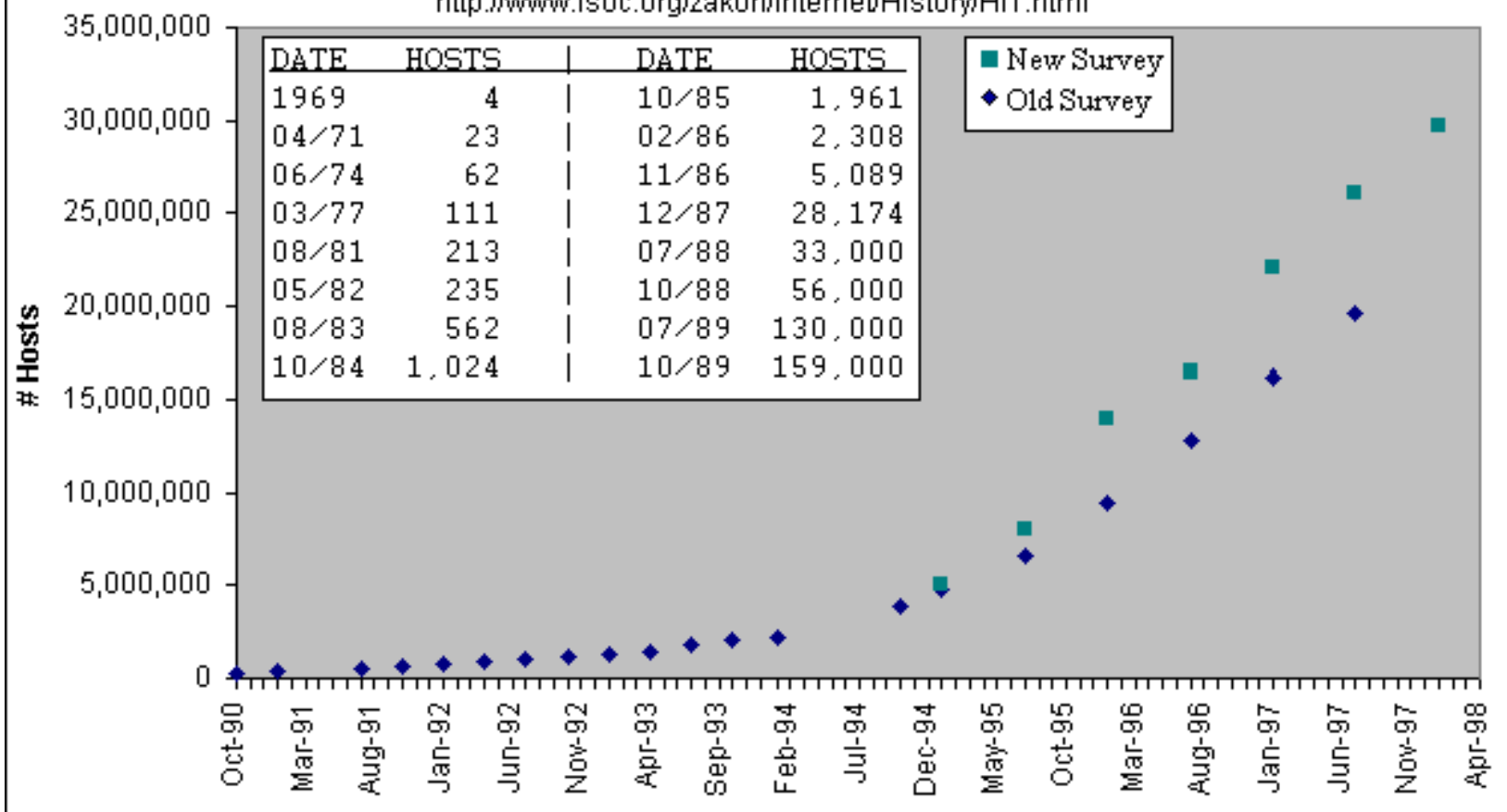

# March 2001



Dr. Vint Cerf presents in Chicago  
at the Drake Hotel on March 2001  
The event was a fund-raiser for the ITRC

Over 115 Million Hosts  
(As of Jan. 2001)

Over 407 Million Users  
(As of Nov. 2000)

218 of 246 Countries  
(As of Jan. 2000)

> 31 Million Domain Names

About 100 TB of Data



By September 2002  
The Internet Reached Two  
Important Milestones:

➤ 200,000,000 IP Hosts

➤ 840,000,000 Users

# Growth of Internet Hosts \*

## Sept. 1969 - Sept. 2002

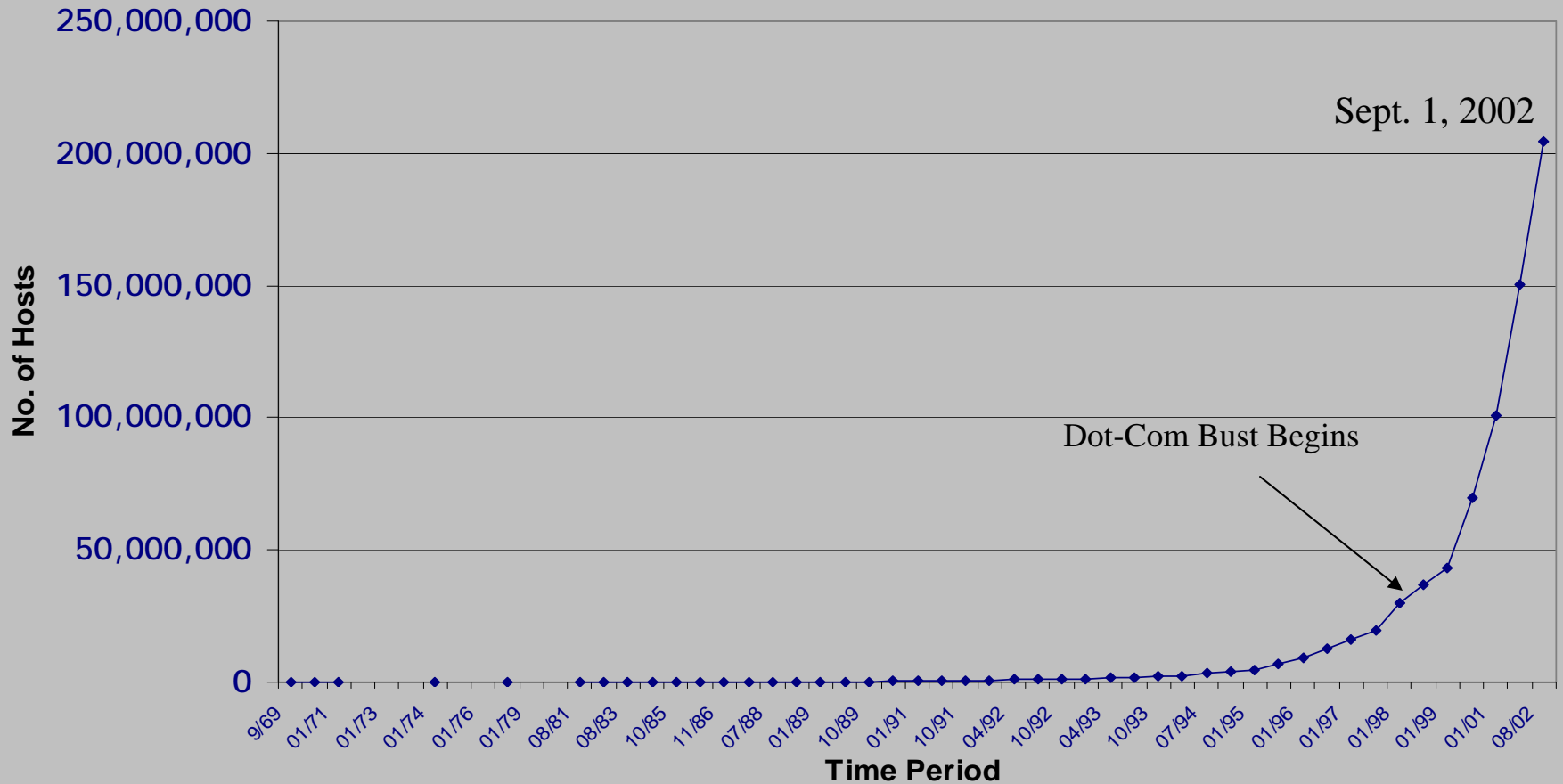

Chart by William F. Slater, III

The Internet was not known as "The Internet" until January 1984, at which time there were 1000 hosts that were all converted over to using TCP/IP.

# The Internet Host Count in Realtime on September 1, 2002 - Over 204,000,000 IP Hosts!!!

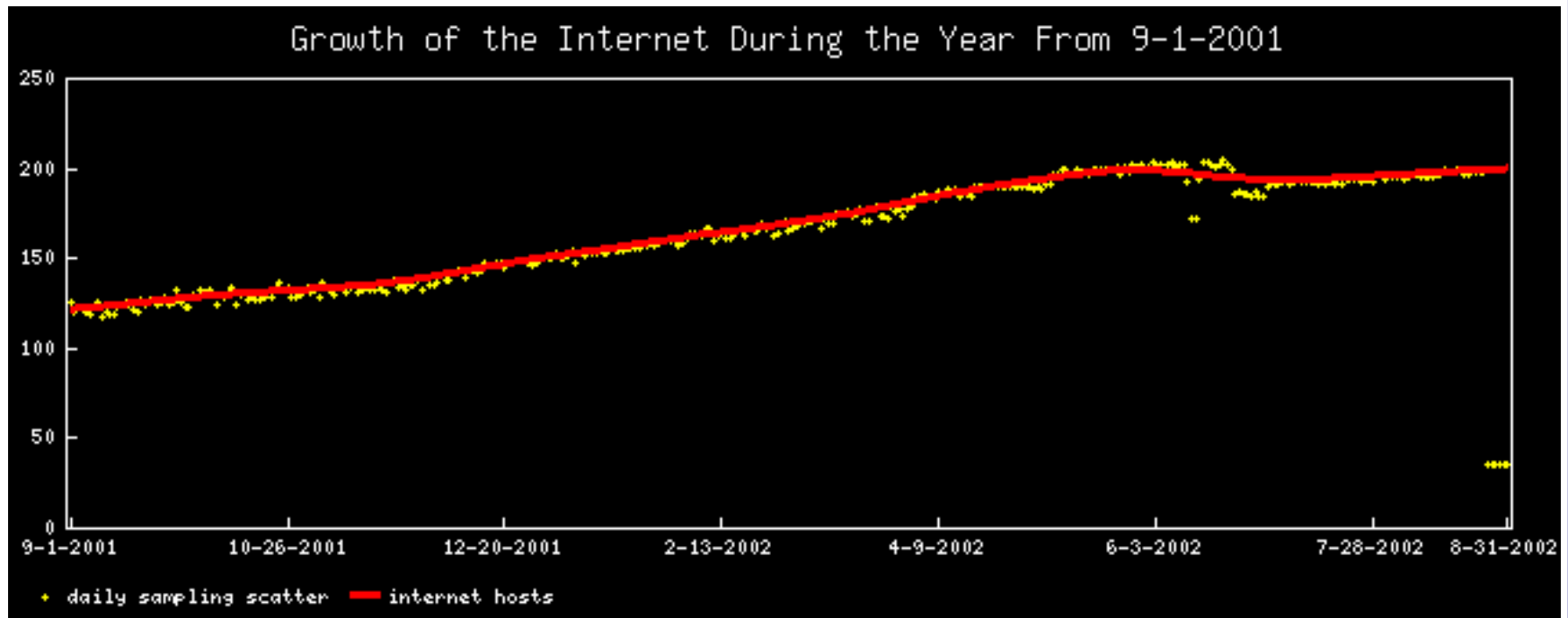
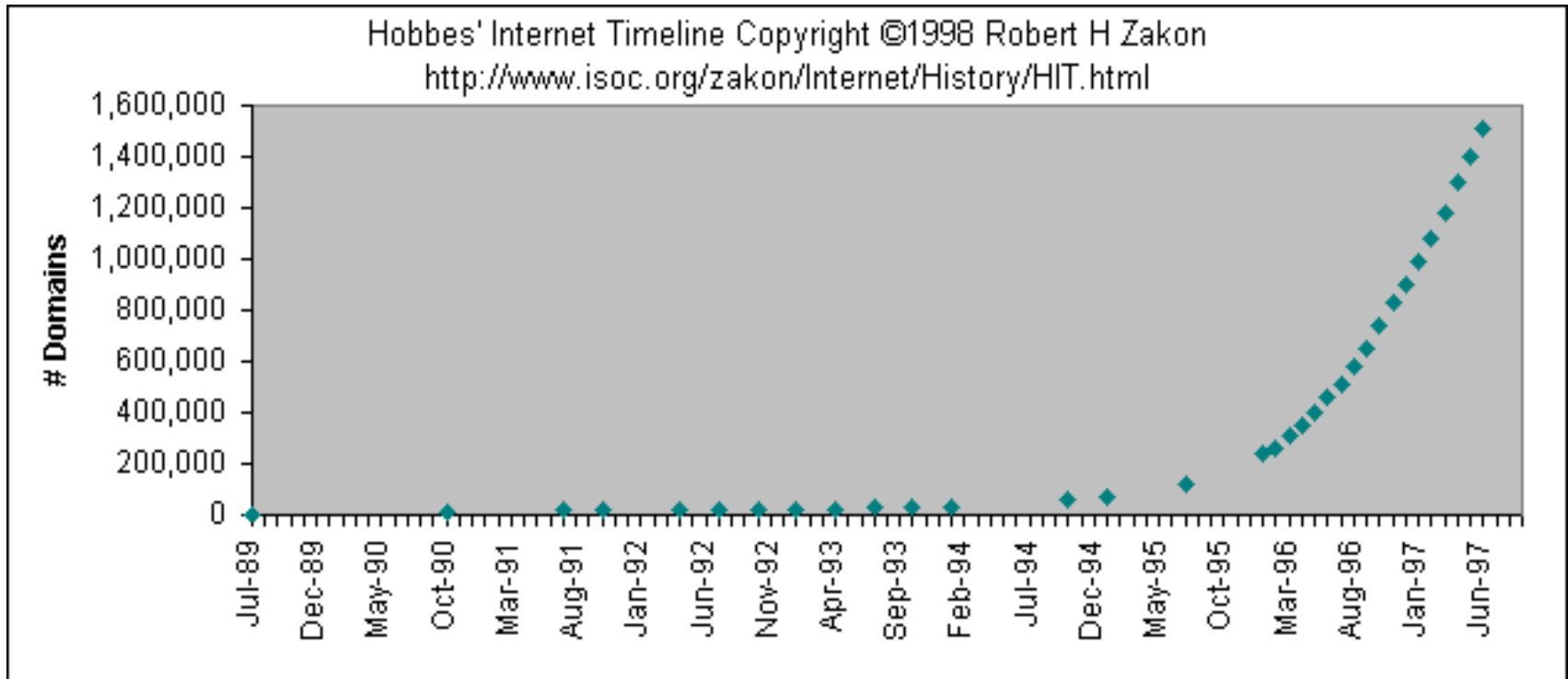

Chart showing Internet Growth  
from Sept. 1, 2001 to Sept. 1, 2002.  
Source Netsizer.com

# Domain Name Registration

## Jan. '89 - Jul. '97



April 2001: 31,000,000 Domain Names!!!

# Statistics from the IITF Report The Emerging Digital Economy \*

- To get a market of 50 Million People Participating:
  - Radio took 38 years
  - TV took 13 years
  - Once it was open to the General Public, The Internet made to the 50 million person audience mark in just 4 years!!!
- <http://www.ecommerce.gov/emerging.htm>
  - Released on April 15, 1998



\* Delivered to the President and the U.S. Public on April 15, 1998 by Bill Daley, Secretary of Commerce and Chairman of the Information Infrastructure Task Force

# Conclusion

- The Internet (and World Wide Web) was have today was created by some very bright, talented people who either had vision, or were inspired by other talented people's visions.
- Though their ideas were not always popular, they pressed ahead.
- Their perseverance and hard work brought us to where we are today.
- There is a lot to be learned by studying these people, their early work and keeping in mind what they had to work with.
- Today, we owe a great deal for the wired world we enjoy, to the hard work of these people.

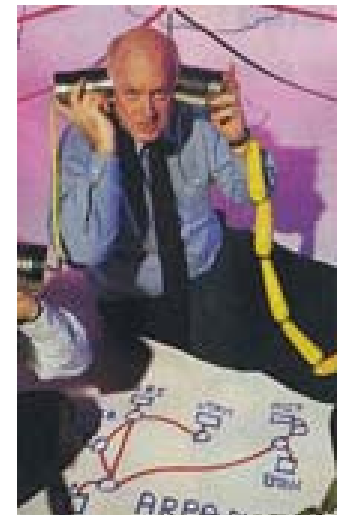
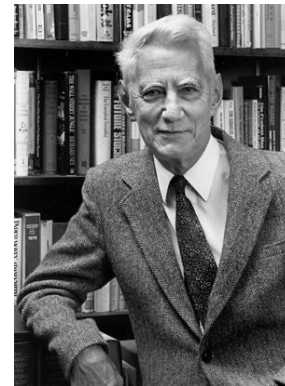



## Questions?



# Sources of Statistical Information

- Netsizer.com - from Telcordia
- CAIDA
- Network Wizards Internet Domain Survey
- RIPE Internet Statistics
- Matrix Information and Directory Services
- Growth of the World Wide Web
- The Netcraft Web Server Survey
- Internet Surveys
- The Internet Society

# Sources of Statistical Information

URLs are underneath!

- [Netsizer.com - from Telcordia](#)
- [CAIDA](#)
- [Network Wizards Internet Domain Survey](#)
- [RIPE Internet Statistics](#)
- [Matrix Information and Directory Services](#)
- [Growth of the World Wide Web](#)
- [The Netcraft Web Server Survey](#)
- [Internet Surveys](#)
- [The Internet Society](#)

# For More Information, Please Contact:

- William F. Slater, III
  - [slater@billslater.com](mailto:slater@billslater.com)
  - [billslater.com](http://billslater.com)
  - [isoc-chicago.org](http://isoc-chicago.org)
  - 773-235-3080